

THIS DOCUMENT MUST NOT BE COPIED WITHOUT OUR WRITTEN PERMISSION, AND THE CONTENTS THEREOF MUST NOT BE IMPARTED TO A THIRD PARTY NOR BE USED FOR ANY UNAUTHORIZED PURPOSE. CONTRAVENTION WILL BE PROSECUTED.

REVISIONS			
REV.	DESCRIPTION	DATE	SIGNATURE
A		2012-02-17	AK

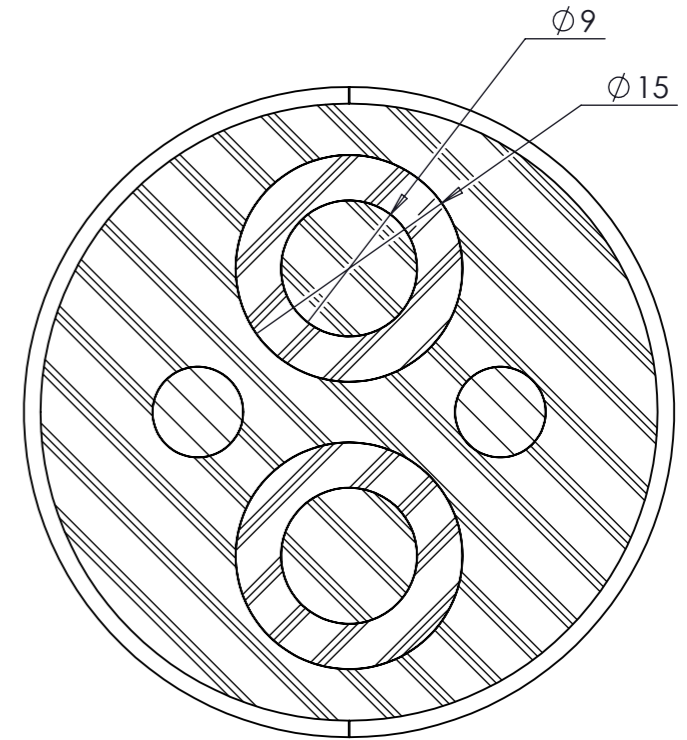

SECTION A-A

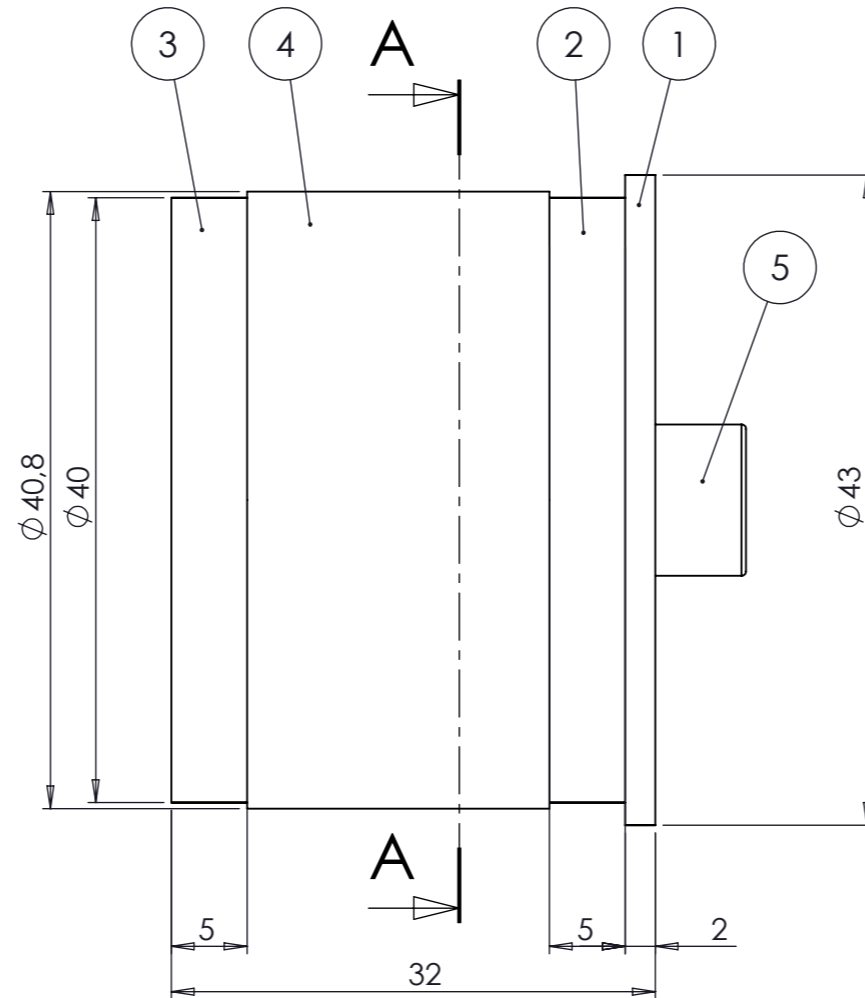
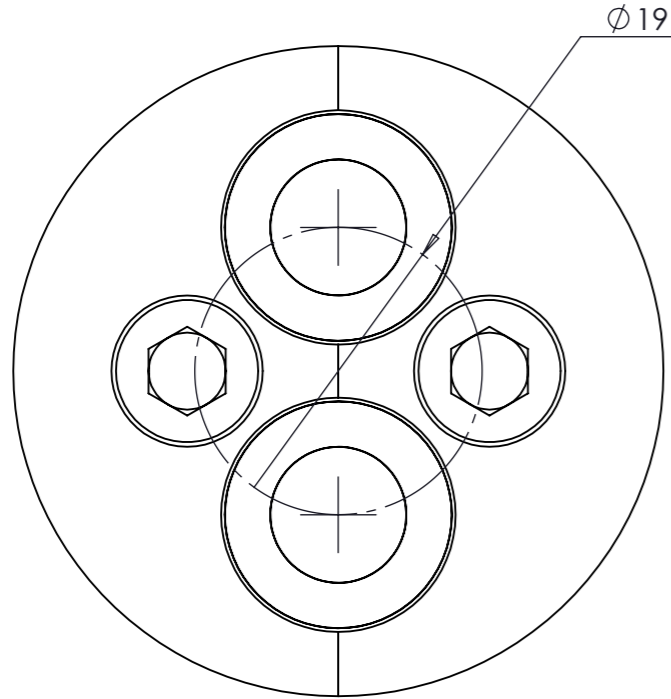
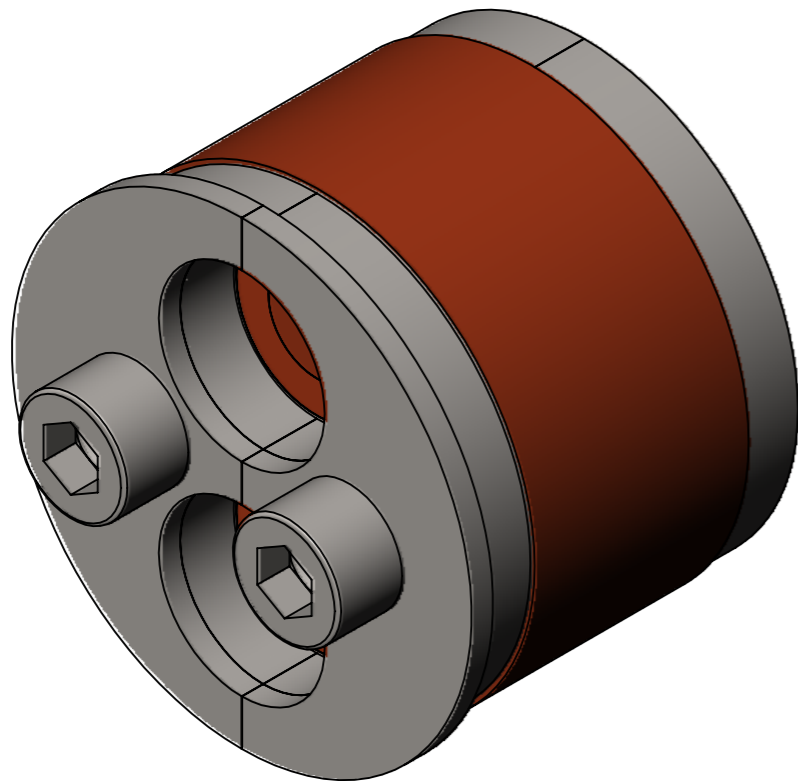

ITEM NO.	DESCRIPTION	DRAWING NUMBER	QTY.
1	CAPTURE PLATE 316L	1100853	2
2	FRONT PLATE 316L	1100853	2
3	BACK PLATE 316L	1100853	2
4	RUBBER SEAL	1100854	1
5	ISO 4762 M6 x 30 --- 30N		2

Ritad Drawn	Kontr. Check	Granskad Reviewed	Godkänd Approved	Tolerans där ej annat anges Tolerance unless otherwise not stated.	Smst. nr. Assembly drawing no.	Ersätter Replaces	E
AK	AK	JF	TF	Ytjämnhet där ej annat anges Surface finish otherwise not stated.		Ersatt av Replaced of	Vikt Weight
120217	120217	120217	120220			Alla mått och uppgifter avser färdig produkt om ej annat anges All measures and other information refer to finished products unless otherwise not stated.	
				SR-38 TYPE 2		Kund ordernr. Customer order no	
						Ritn. nr. Draw. no.	Rev.
						1120078	A