

THIS DOCUMENT MUST NOT BE COPIED WITHOUT OUR WRITTEN PERMISSION, AND THE CONTENTS THEREOF MUST NOT BE IMPARTED TO A THIRD PARTY NOR BE USED FOR ANY UNAUTHORIZED PURPOSE. CONTRAVENTION WILL BE PROSECUTED.

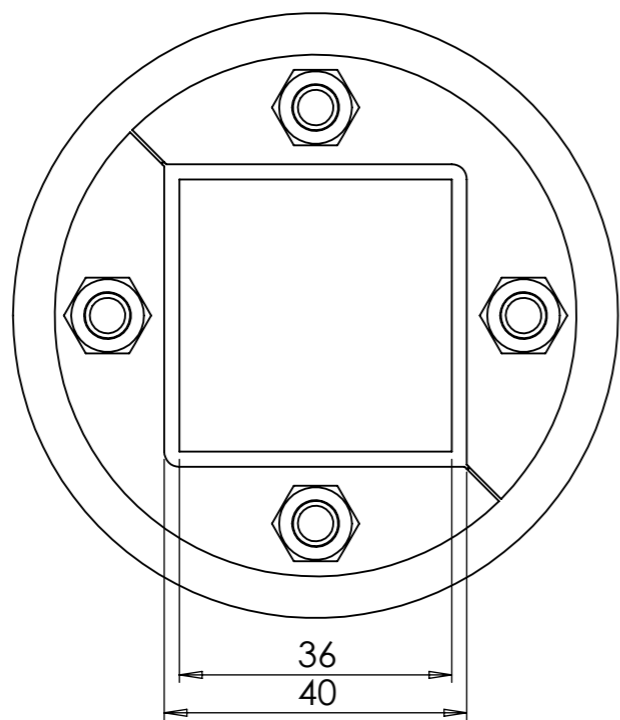

REVISIONS			
REV.	DESCRIPTION	DATE	SIGNATURE
A	INFORMATION DRAWING	2024-03-06	SS

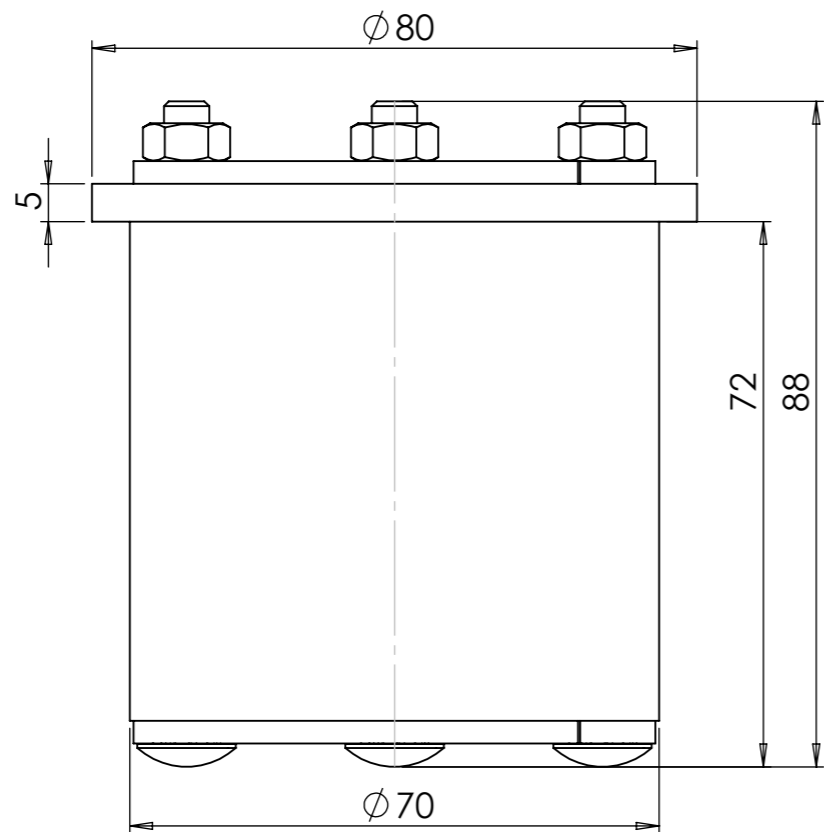
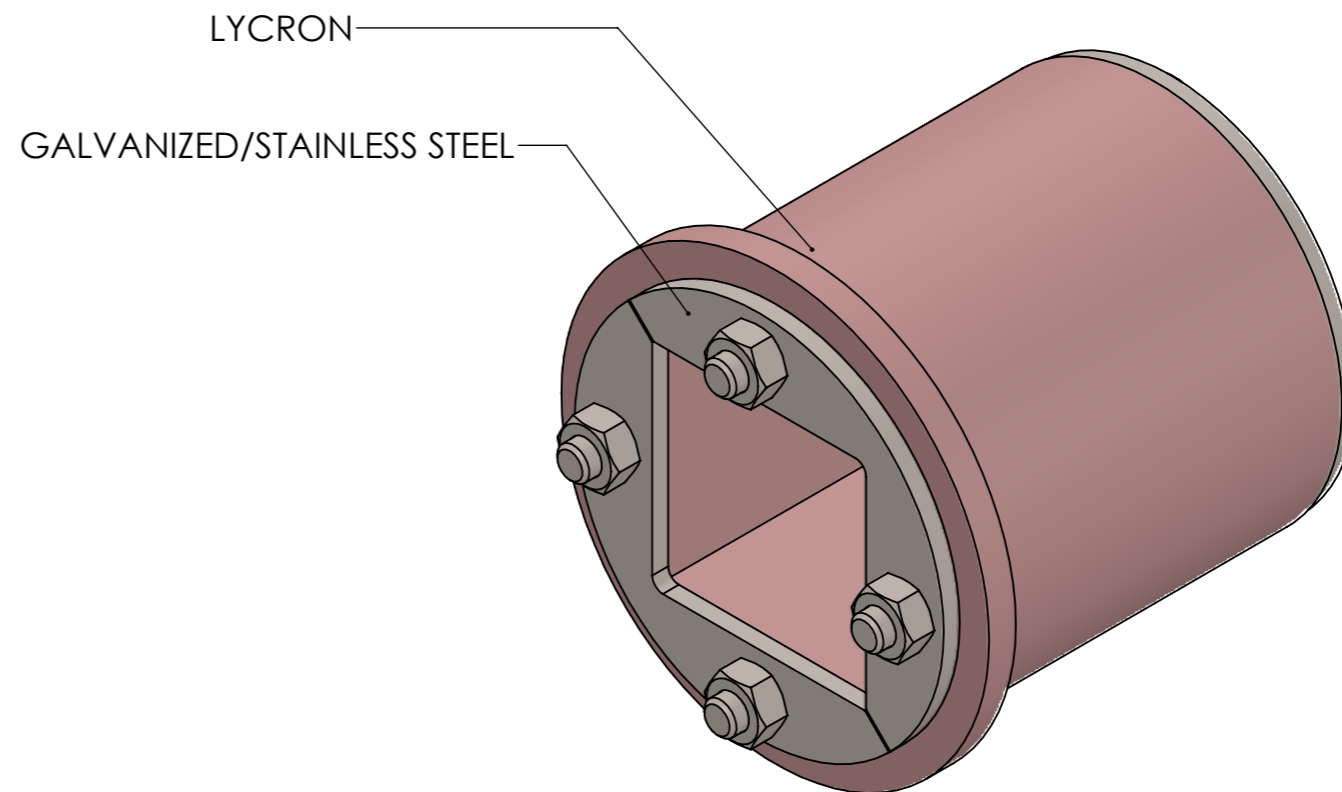

FOR HOLES 70-71mm

Ritad Drawn	Kontr. Check	Granskad Reviewed	Godkänd Approved	Tolerans där ej annat anges Tolerance unless otherwise not stated.	Smt. nr. Assembly drawing no.	Ersätter Replaces	E
PB	PB	OF	ML	Ytjämnhet där ej annat anges. Surface finish otherwise not stated.	Material	Ersatt av Replaced of	Vikt Weight 0.45
230712	240307	240404	240409	Alla mått och uppgifter avser färdig produkt om ej annat anges All measures and other information refer to finished products unless otherwise not stated.		Kund ordernr. Customer order no	
				RGP-70 INFORMATION DRAWING		Ritn. nr. Draw. no.	Rev.
						1230238	A